

# JUMITECH

---

## DALI Daylight

### Datasheet Interface



DALI-Bluetooth Interface for setting  
up Lunatone DALI-systems

Art. Nr. 89453863

# DALI Daylight Interface

## Overview

- Interface for changing system parameters of DALI-Systems via mobile device
- Android and IOS App available
- all modules in the Bluetooth range are shown in the app
- suitable for the configuration of:
  - light level (manual and auto)
  - circadian curve of DALI CDC
  - motion detectors
  - RTC-timers
- DALI LS: change between manual and automatic control of the light level, setup reference light level
- DALI CDC: Setup the circadian curve (Start/Peak/Stop)
- DALI RTC Timer: 2 on-intervals per weekday
- Motion detector: setup of light level and hold time
- pin protected access
- The DALI Daylight module is configured with the help of the DALI-Cockpit, there the devices, which can be accessed by the app, have to be defined
- Multimaster capable, several modules and other control devices can be installed on the same DALI-line
- The module is supplied directly by the DALI signal line
- suitable for the integration in smart luminaires

## Specification, Characteristics

Type	DALI Daylight Interface
article number	89453863
supply	aus DALI-Bus
typ. current consumption	4 mA
output	DALI
storage temperature	-20°C ... +75°C
operating temperature	-20°C ... +75°C
protection class	IP20
connecting wires cross section	0.5-1.5 mm <sup>2</sup>
dimensions (lxwxh)	59x33x15 mm
max. number of areas	5
max. number of devices per type (sensor, CDC, RTC)	5

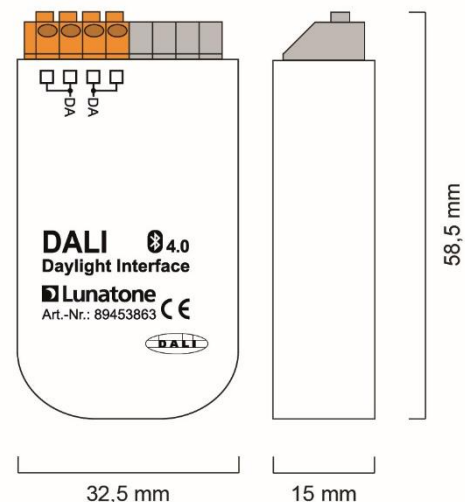

Bluetooth 4.0: Low Energy



Abmessungen

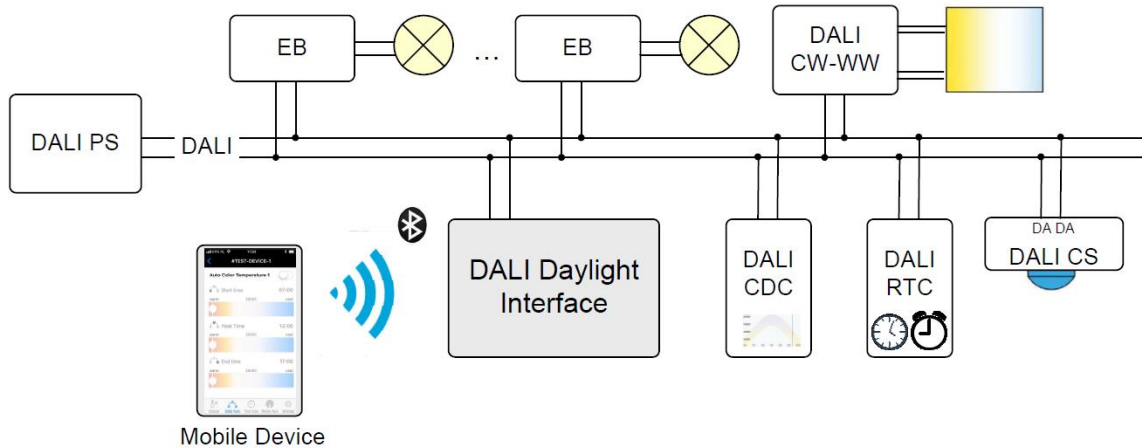

## Installation

- The DALI Daylight module is supplied directly by the DALI-line (current consumption <4 mA)
- The connection to the DALI-line is polarity free and is protected against overvoltage (mains voltage)
- The smart module is suitable for back box mounting
- Wiring with solid or fine wire with conductor cross section of 0.5-1.5 mm<sup>2</sup>

(once a device is assigned the status can be changed with the app).

For luminaires manual or sensor based control can be selected. Dependent on this selection either a luminaire / group of luminaires or a sensor address can be selected. If a sensor is selected the luminaire address will be copied directly from the sensor settings.

## Addressing and Configuration

The DALI Daylight module is detected by the PC-Software DALI-Cockpit during the addressing procedure. Afterwards the device can be configured.

DALI-Cockpit and DALI-USB interface are used only for the configuration and can be removed afterwards.

For each device category (luminaires, DALI CDC, DALI RTC Timer, motion detectors) up to 5 devices, that have previously been found during the addressing procedure, can be assigned to the DALI Daylight module. Beside each device the status of the device is shown

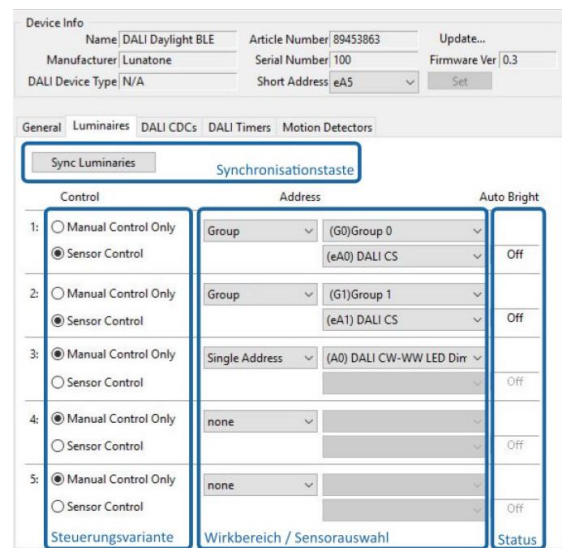

In the same way DALI CDCs, DALI RTC timers and motion detectors can be set up for app access in the corresponding tab:

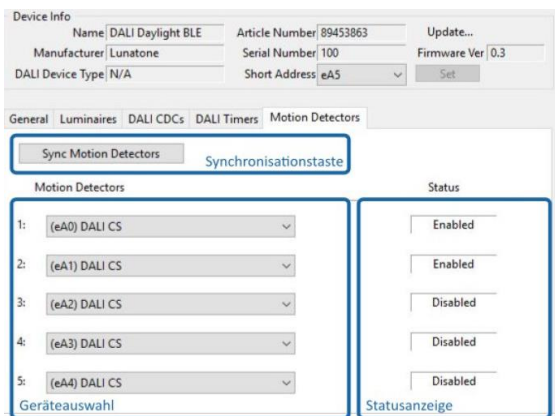
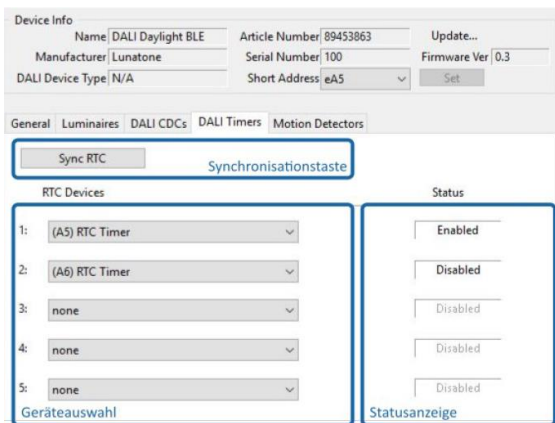
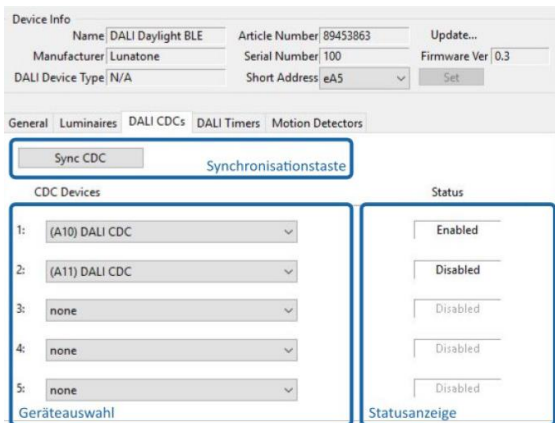

accessed. For each category of devices the app offers a tab at which the assigned devices can be configured and/or controlled.

Luminaires:

- a: On/Off
- b: Automatic/Manual lighting control
- c: light level reference
- d: colour temp slider (for DT8-Tc capable luminaires)

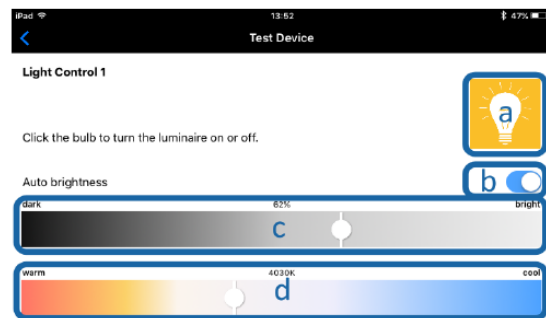

Colour Auto:

Set up of Start/Peak/Stop-time and colour temperature

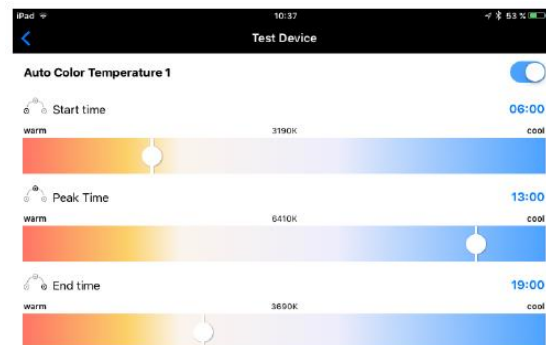

Timer Auto:

Setup of 2 intervals per weekday

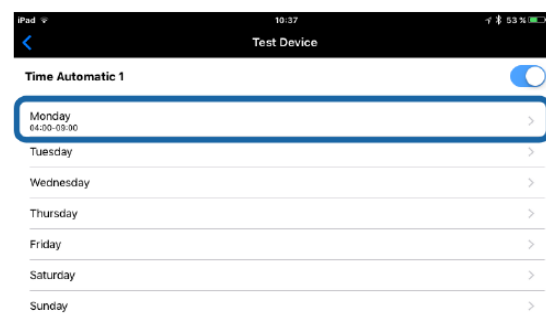

## Control via App

The parameters of the assigned DALI devices can be changed with an IOS or Android mobile device and the DALI Daylight app. System parameters can be adapted easily at any time without the need for additional interfaces and tools (like DALI-Cockpit or DALI USB interface).

The range of the bluetooth-connection is approximately 10m.

All DALI-Daylight modules in the detection range are shown in the app and can be

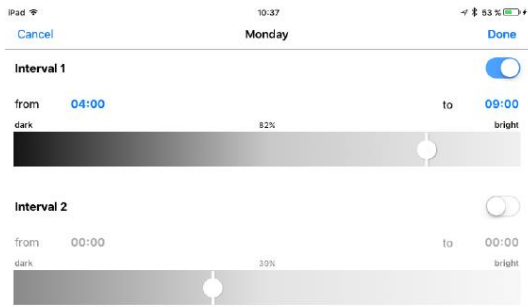

## Motion Auto:

- Activate/Deactivate sensor
- Setup ambient light threshold
- Light-level and holdtime
- Second light level and holdtime

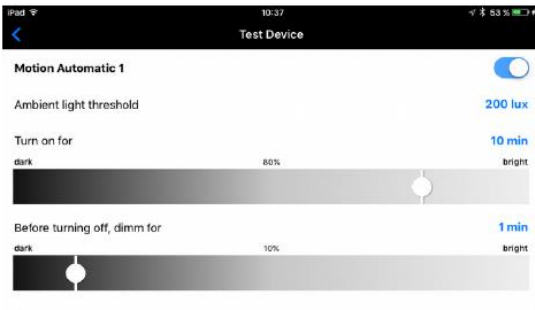

## Purchase Order Information

**Art.Nr. 89453863**, DALI-Daylight interface for setting up important parameters of DALI-systems with IOS or Android mobile device

## Additional Information

Datasheets and manuals

<https://jumitech/produkter>

DALI-Cockpit – free configuration tool from Lunatone for DALI systems

<http://lunatone.at/en/downloads/Lunatone-DALI-Cockpit.zip>

## Contact

Technical Support: [support@jumitech.dk](mailto:support@jumitech.dk)

Requests: [salg@jumitech.dk](mailto:salg@jumitech.dk)

[www.jumitech.dk](http://www.jumitech.dk)

# JUMITECH



## Disclaimer

Subject to change. Information provided without guarantee. The datasheet refers to the current delivery.

The compatibility with other devices must be tested in advance to the installation.